

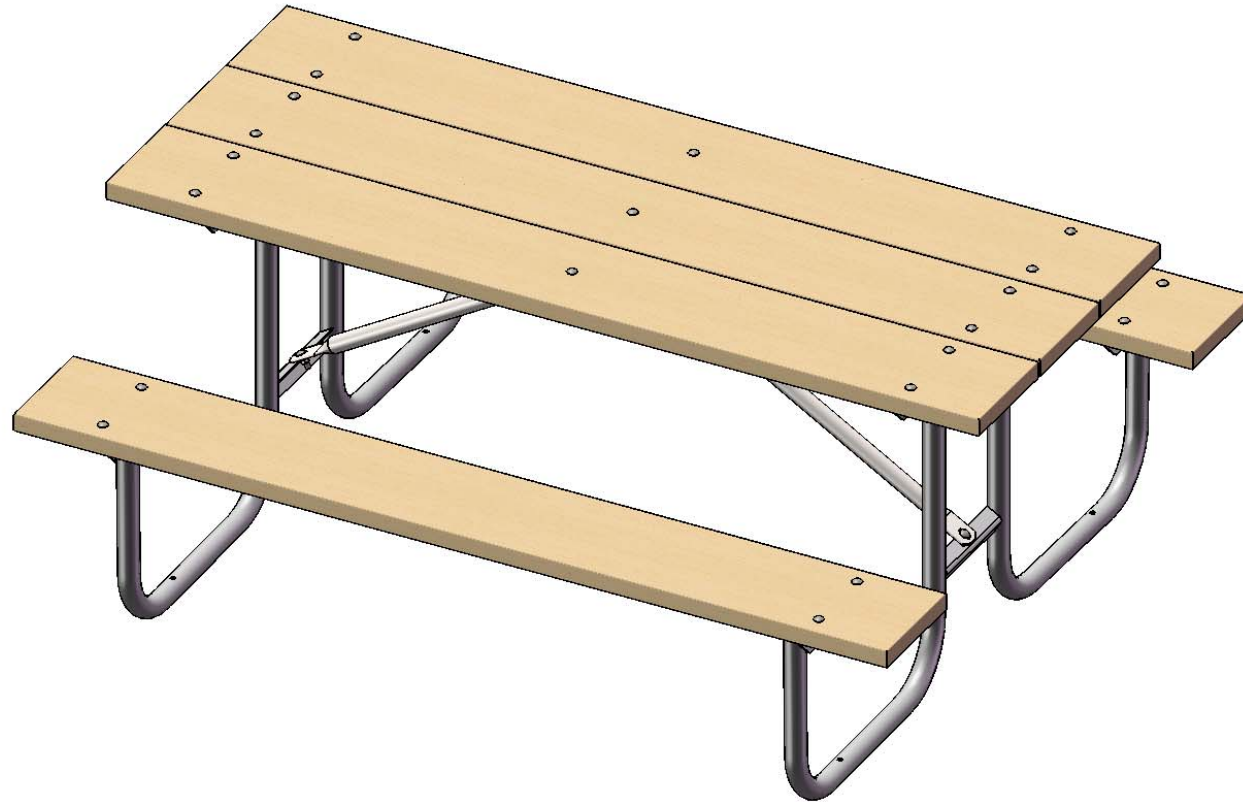

A PLAYCORE Company



Model # 158-W6



A PLAYCORE Company

SAFETY WARNINGS & EQUIPMENT INSPECTION

- Owners and installers please note these safety warnings and make use of this checklist on a regular basis.
- Follow installation instructions when erecting equipment.
- Ground surfaces around equipment should be restored as needed. Concrete footings should never be exposed. Surface depth should comply with ASTM and CPSC specifications.
- Check for and repair damage caused by wear or vandalism, a major factor in injury causing situations.
- All protruding bolts should be covered or cut off and finished smooth. Sharp edges on pipes should be capped or removed. Check for bent, broken, or severely worn pipe, and replace.
- All equipment should be free of rust and repainted whenever necessary to deter rusting.
- We provide our customers with layout sheets and installation instructions. Please keep on file the specifications sheet that contains the listing of every part used.
- Never add components not intended for use with this product.
- Regular maintenance is necessary in this and all park and recreational equipment to insure the safety of the user.
- Note: Proper maintenance of equipment requires regular tightening of all bolts, nuts, and setscrews.
- Note: Regular checking of all parts, castings, etc. should be made. If a part is broken or worn, it should be replaced immediately.
- Check to be sure all fittings are tight and that bars and pipes do not move.
- Replace all worn S-hooks. S-hooks must be completely closed. Failure to close S-hooks can result in serious injury to the user. NEVER reuse S-hooks.
- Test for free movement of swing hanger and other moving attached parts.
- Check for worn chains and replace them.
- A soft resilient surface should be placed under all swings extending at least twice the height of the top rail both front and back.

HARDWARE

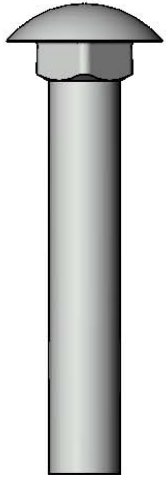

3/8" x 2-1/4"
Carriage Bolt

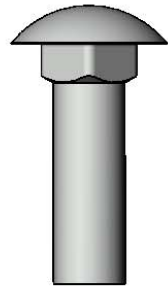

3/8" x 1-1/4"
Carriage Bolt

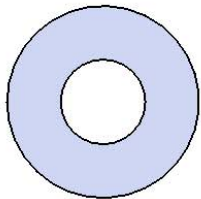

3/8" Washer

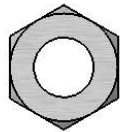

3/8" Hex Nut

TOOLS REQUIRED

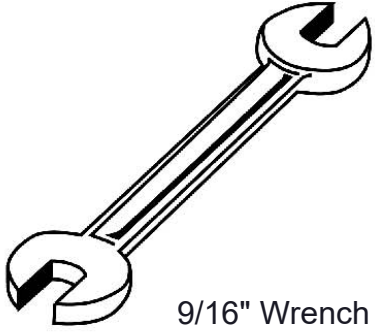

9/16" Wrench



9/16" Socket Wrench

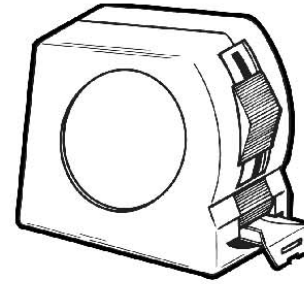

Tape Measure

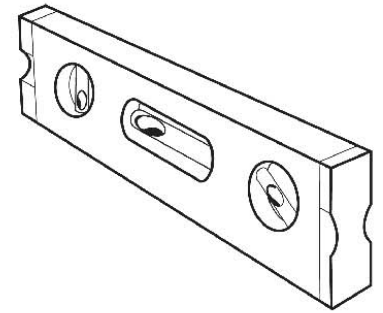

Level

ULTRA SITE PRODUCT SPECIFICATIONS

158-W6 6' PORTABLE PICNIC TABLE WALK-THROUGH DESIGN

Top & Seats: Pressure Treated - 2" x 4" No. 1 Southern Yellow Pine pressure treated lumber.
Redwood Stain - 2" x 4" No. 1 Southern Yellow Pine with a redwood stain wood preservative
Untreated - 2" x 4" No.1 Southern Yellow Pine

Frame: 1-5/8" O.D. x 12 gauge pre-galvanized structural steel tubing. One 1 1/2" x 3/4" x 1/8" center channel shall be mechanically attached to the bottom side of tabletop to prevent warping of wood and to attach cross braces, thus providing over all strength and rigidity. Cross braces 1 5/16" O.D. x 14 gauge pre-galvanized structural steel tubing. Brace attachment points 1-1/2"x1-1/2"x3/16" steel angle. All tabletop and seat mounting brackets shall be precision punched and fabricated from 2" x 2" x 7 gauge formed angle. Legs are bent over a mandrel through the bend radius producing a wrinkle free bend. All electrically MIG welded.

Frame Coating: Electrostatic powder coated application oven cured or hot dipped galvanized.

Hardware: Hardware shall be hot-dipped galvanized.

Dimensions: 6' portable picnic table walk-through design. Top is 28-1/4" wide x 72" long and is 30" high. Seats are 9-1/4" wide x 72" long and 18" high. Outside to outside dimension is 57" x 72".

COMPONENTS

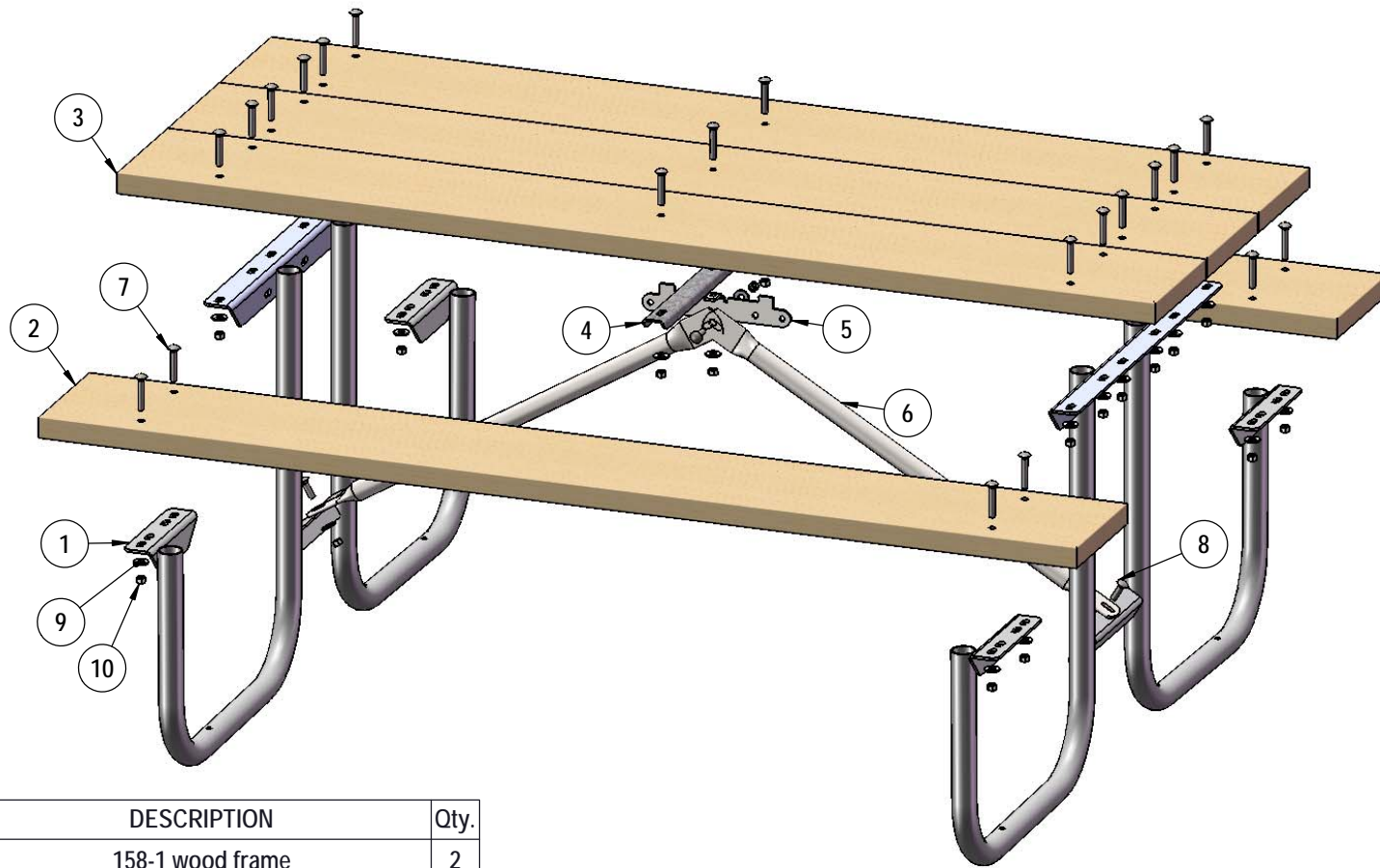

ITEM NO.	PartNo	DESCRIPTION	Qty.
1	W158-1	158-1 wood frame	2
2	XXX72-2x10-S1	2 x 10 Pressure Treated/Untreated/Redwood Stained Seat Plank (6')	2
3	XXX72-2x10-T1	2 x 10 Pressure Treated/Untreated/Redwood Stained Top Plank (6')	3
4	01-04-0507	center c channel 3 slot (new)	1
5	01-04-0508	wood table center bracket	1
6	01-04-0509	33-3/16" wood brace	2
7	33-06-0113	3/8" x 2-1/4" Carriage Bolt (Galv)	23
8	33-06-0114	3/8" x 1-1/4" Carriage Bolt (Galv)	3
9	33-02-0010	3/8" Galvanized Steel Flat Washer	26
10	33-01-0015	3/8" Hex Nut (GALV)	26

Optional Surface Mount Hardware:
5/16" x 4-1/2" Concrete Expansion Anchor Bolts
(Not Included)

STEP 1

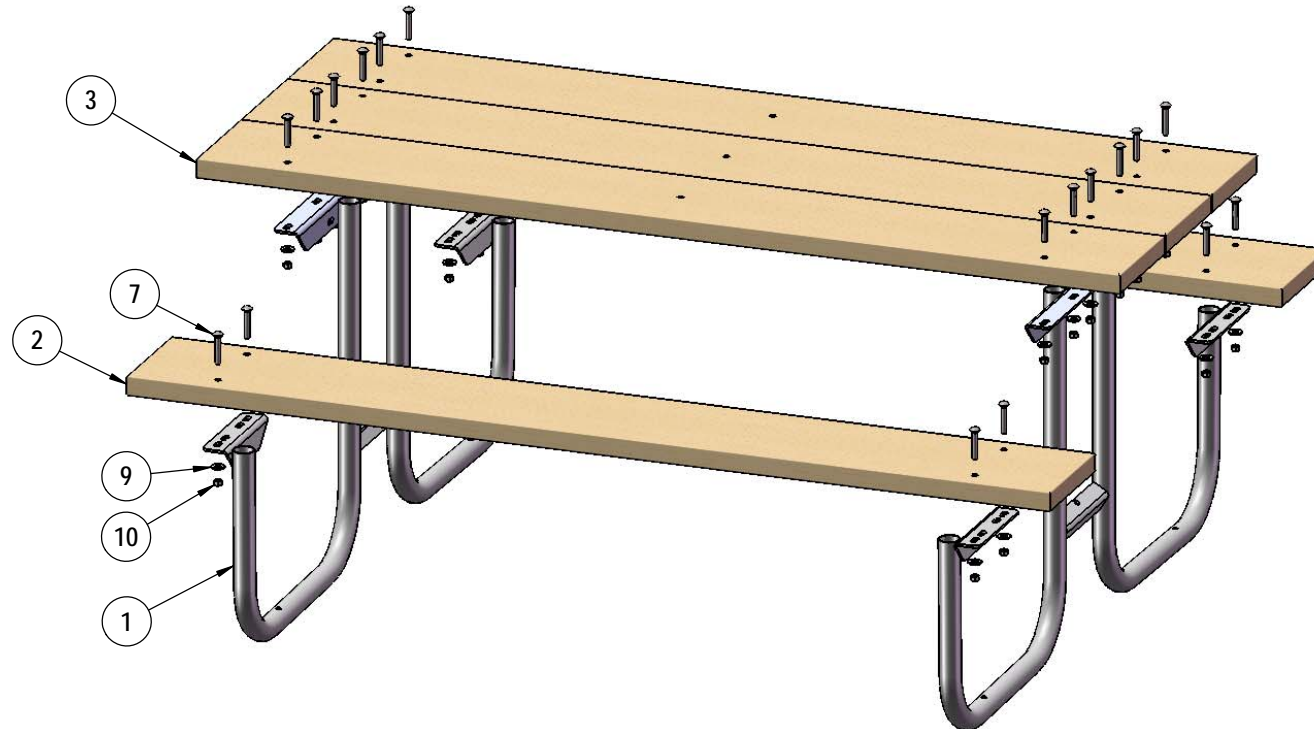

Attach the Wood Planks to the 158 Frames as shown using specified hardware.

STEP 2

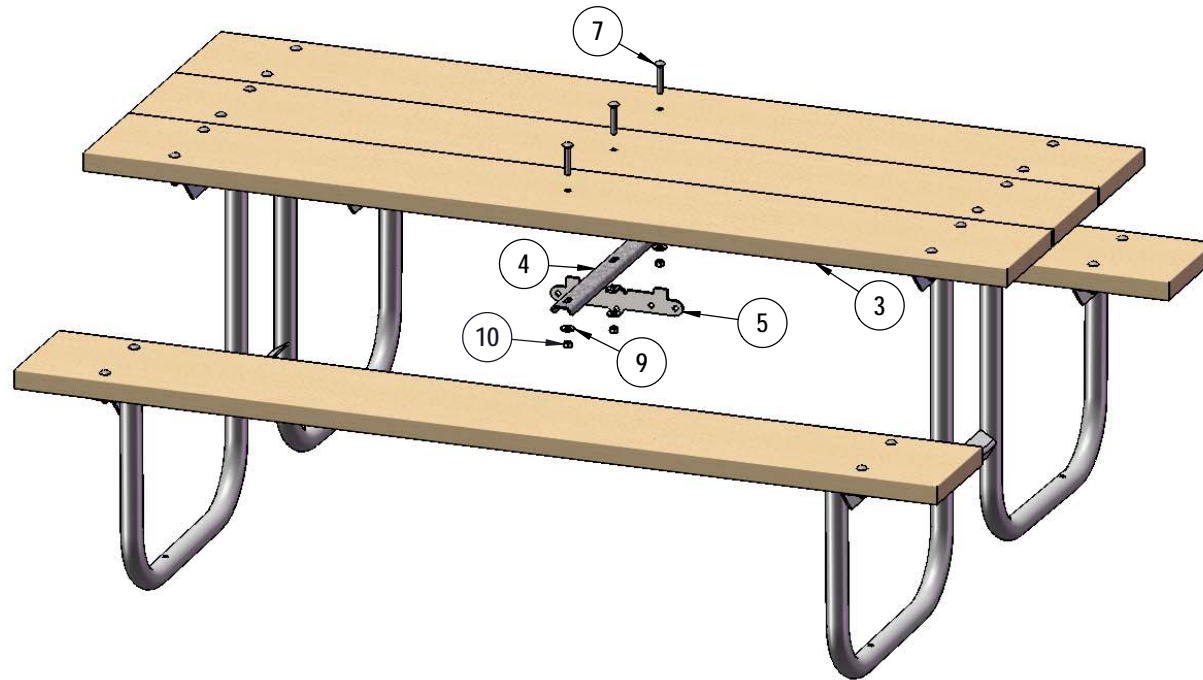

Attach the Wood Center Bracket and C-Channel and the Wood Planks as shown using specified hardware.

STEP 3

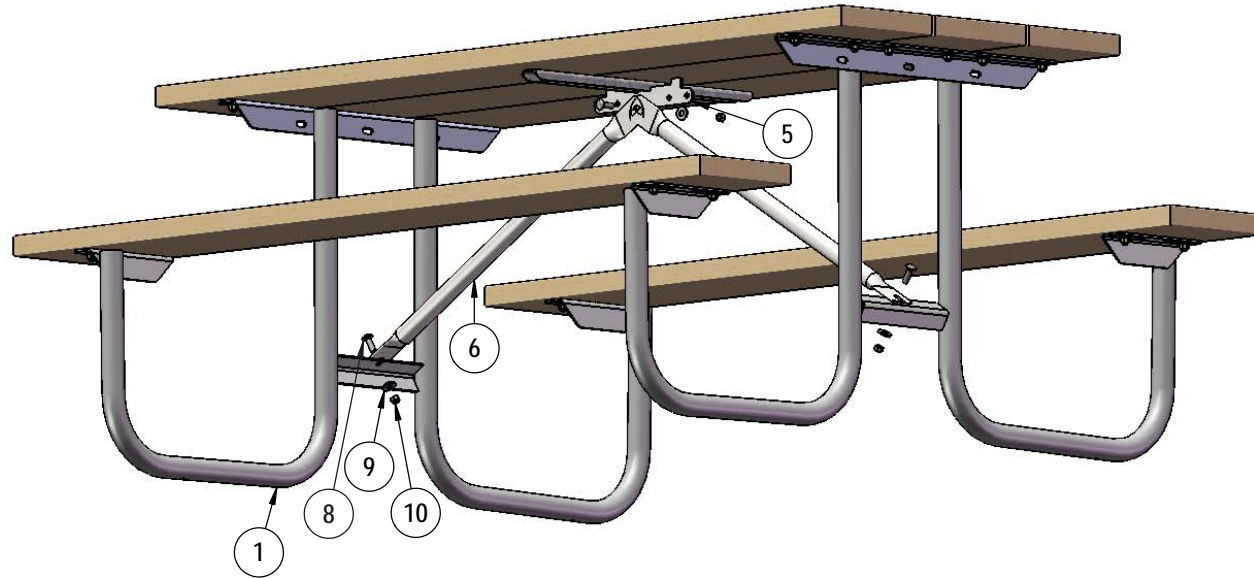

Attach the 33-3/16" Braces to the Wood Center bracket and the 158 Frames as shown using specified hardware.

OVERALL DIMENSIONS

