

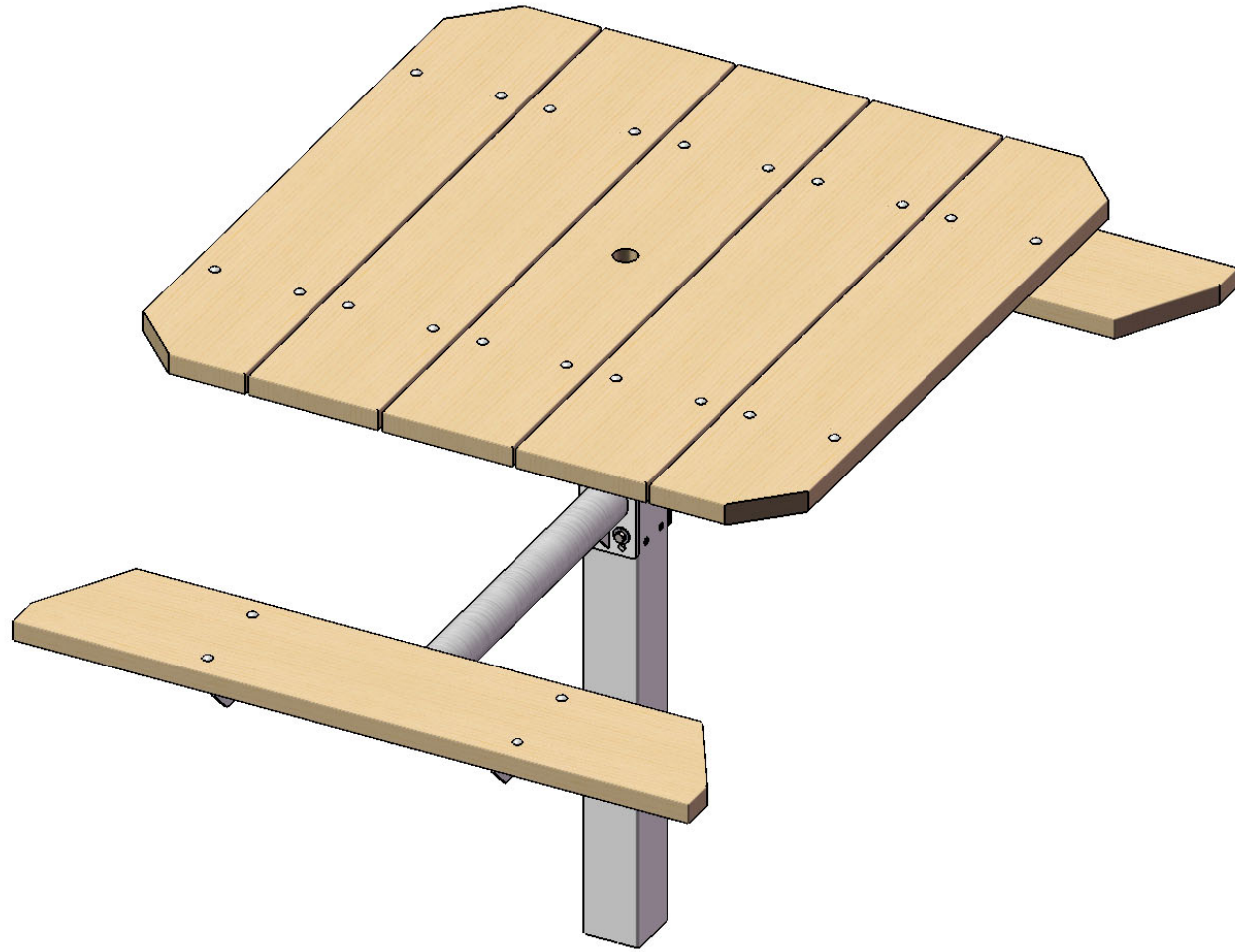

A PLAYCORE Company



Model #
338SH2-PT48
338SH2-U48
338SH2-T48



A PLAYCORE Company

SAFETY WARNINGS & EQUIPMENT INSPECTION

- Owners and installers please note these safety warnings and make use of this checklist on a regular basis.
- Follow installation instructions when erecting equipment.
- Ground surfaces around equipment should be restored as needed. Concrete footings should never be exposed. Surface depth should comply with ASTM and CPSC specifications.
- Check for and repair damage caused by wear or vandalism, a major factor in injury causing situations.
- All protruding bolts should be covered or cut off and finished smooth. Sharp edges on pipes should be capped or removed. Check for bent, broken, or severely worn pipe, and replace.
- All equipment should be free of rust and repainted whenever necessary to deter rusting.
- We provide our customers with layout sheets and installation instructions. Please keep on file the specifications sheet that contains the listing of every part used.
- Never add components not intended for use with this product.
- Regular maintenance is necessary in this and all park and recreational equipment to insure the safety of the user.
- Note: Proper maintenance of equipment requires regular tightening of all bolts, nuts, and setscrews.
- Note: Regular checking of all parts, castings, etc. should be made. If a part is broken or worn, it should be replaced immediately.
- Check to be sure all fittings are tight and that bars and pipes do not move.
- Replace all worn S-hooks. S-hooks must be completely closed. Failure to close S-hooks can result in serious injury to the user. NEVER reuse S-hooks.
- Test for free movement of swing hanger and other moving attached parts.
- Check for worn chains and replace them.
- A soft resilient surface should be placed under all swings extending at least twice the height of the top rail both front and back.

HARDWARE

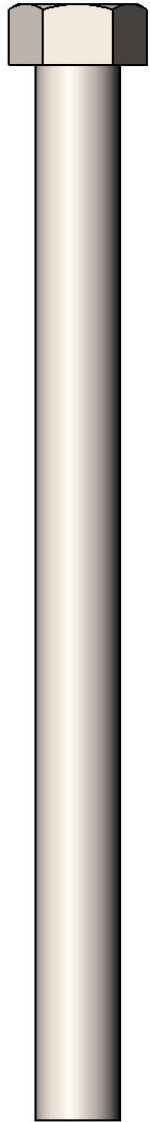

7/16" x 5-1/2"
Machine Bolt

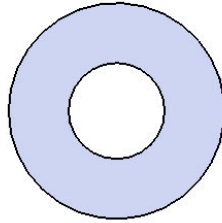

7/16" Washer

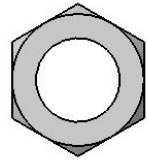

7/16" Hex Nut

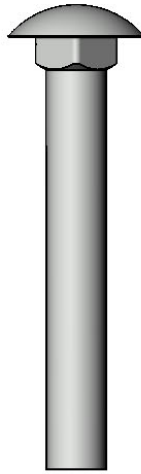

5/16" x 2-1/4"
Carriage Bolt

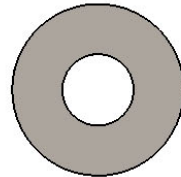

5/16" Washer

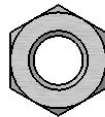

5/16" Hex Nut

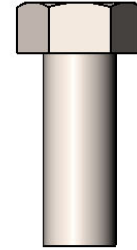

3/8" x 1"
Machine Bolt

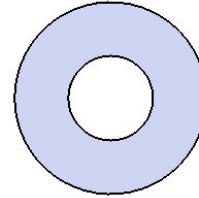

3/8" Washer

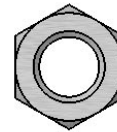

3/8" Hex Nut

TOOLS REQUIRED

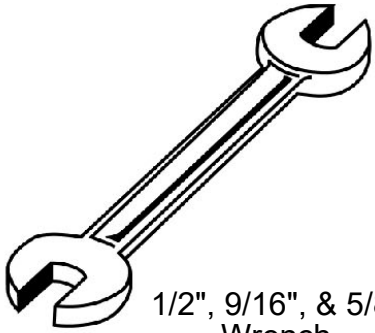

1/2", 9/16", & 5/8"
Wrench

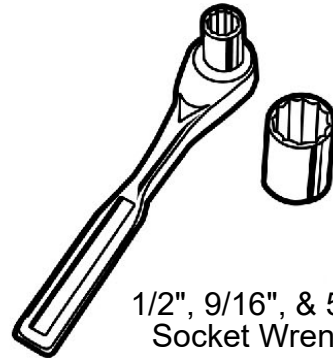

1/2", 9/16", & 5/8"
Socket Wrench

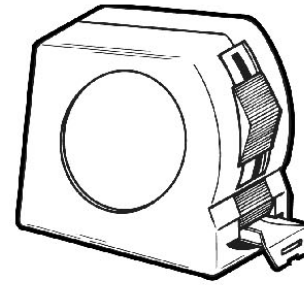

Tape Measure

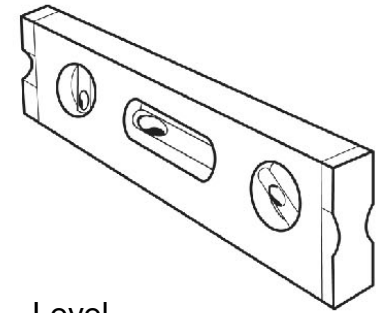

Level

ULTRA SITE PRODUCT SPECIFICATIONS

338SH2-PT48, 338SH2-U48, 338SH2-T48 48" SQUARE INGROUND TABLE WITH 2 SEATS

Top & Seats:

Pressure Treated - 2" x 10" No. 1 Southern Yellow Pine pressure treated lumber.

Redwood Stain - 2" x 10" No. 1 Southern Yellow Pine with a redwood stain wood preservative

Untreated - 2" x 10" No.1 Southern Yellow Pine

Frame: Main support column is 4"x4"x11 gauge pre-galvanized structural steel tubing. Arms are fabricated from 2-7/8" O.D. x 12 gauge pre-galvanized structural steel tubing welded to 3/8" laser cut plates for attachment to the main column and 2"x2"x3/16" structural steel angle for lateral seat support. Seat mounting angle is 2" x 2" x 3/16" formed steel angle which is MIG welded to the arms. Table top attachment structure is fabricated from 2"x2"x3/16" structural steel angle.

Frame Coating: Electrostatic powder coated application oven cured or optional hot dipped galvanized.

Hardware: All zinc coated steel hardware fasteners.

Dimensions: Top is 48" x 47-1/4" x 31-1/2" high. Seats are 9-1/4" wide x 48" long x 17-1/2" high. Outside to outside dimensions of 2 seat table is 74" x 48".

COMPONENTS

ITEM NO.	PartNo	DESCRIPTION	QTY
1	P-338S or G-338S	338 IG post asem	1
2	01-04-0830	48" wood-recycled table H frame	1
3	W-338-ARM or G-338-ARM	338 wood arm	2
4	33-05-0036	3/8" x 1" Machine Bolt (Zinc)	8
5	33-06-0006	5/16" x 2 1/4" Carriage Bolt (Zinc)	28
6	33-02-0002	3/8" Zinc Plated Washer	16
7	33-02-0004	7/16" SS Washer	8
8	33-02-0001	5/16" Zinc Plated Washer	28
9	33-01-0002	3/8" Hex Nut (Zinc)	8
10	33-01-0006	7/16" Hex Nut (SS)	4
11	33-01-0001	5/16" Hex Nut (Zinc)	28
12	33-06-0050	7/16" x 5-1/2" Machine Bolt	4
13	PT48-2x10-MS, RST48-2x10-MS, or U48-2x10-MS	2 x 10 Pressure Treated Mitered Seat Plank (48"), 2 x 10 Redwood Stained Mitered Seat Plank (48"), or 2 x 10 Untreated Mitered Table Plank (48")	2
14	PT48-2x10-UT, RST48-2x10-UT, or U48-2x10-UT	2 x 10 Pressure Treated Umbrella Table Plank (48"), 2 x 10 Redwood Stained Umbrella Table Plank (48"), or 2 x 10 Untreated Umbrella Table Plank (48")	1
15	PT48-2x10-T, RST48-2x10-T, or U48-2x10-T	2 x 10 Pressure Treated Table Plank (48"), 2 x 10 Redwood Stained Table Plank (48"), or 2 x 10 Untreated Table Plank (48")	2
16	PT48-2x10-MT, RST48-2x10-MT, or U48-2x10-MT	2 x 10 Pressure Treated Mitered Table Plank (48"), 2 x 10 Redwood Stained Mitered Table Plank (48"), or 2 x 10 Untreated Mitered Table Plank (48")	2

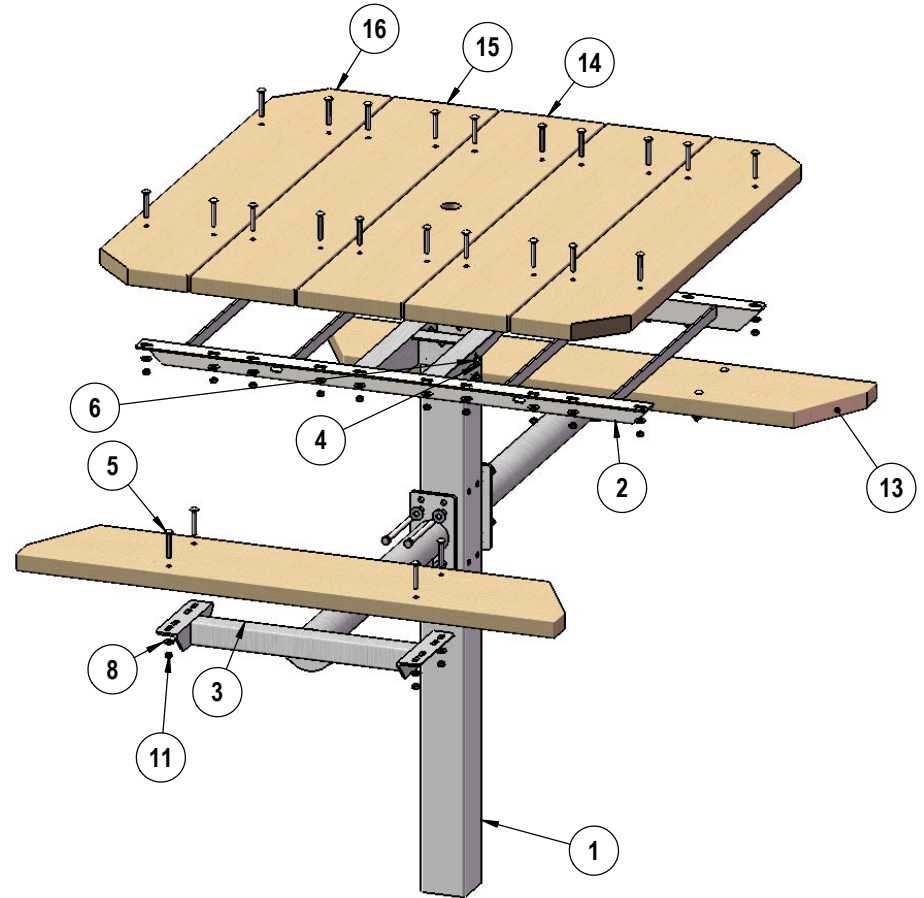

STEP 1

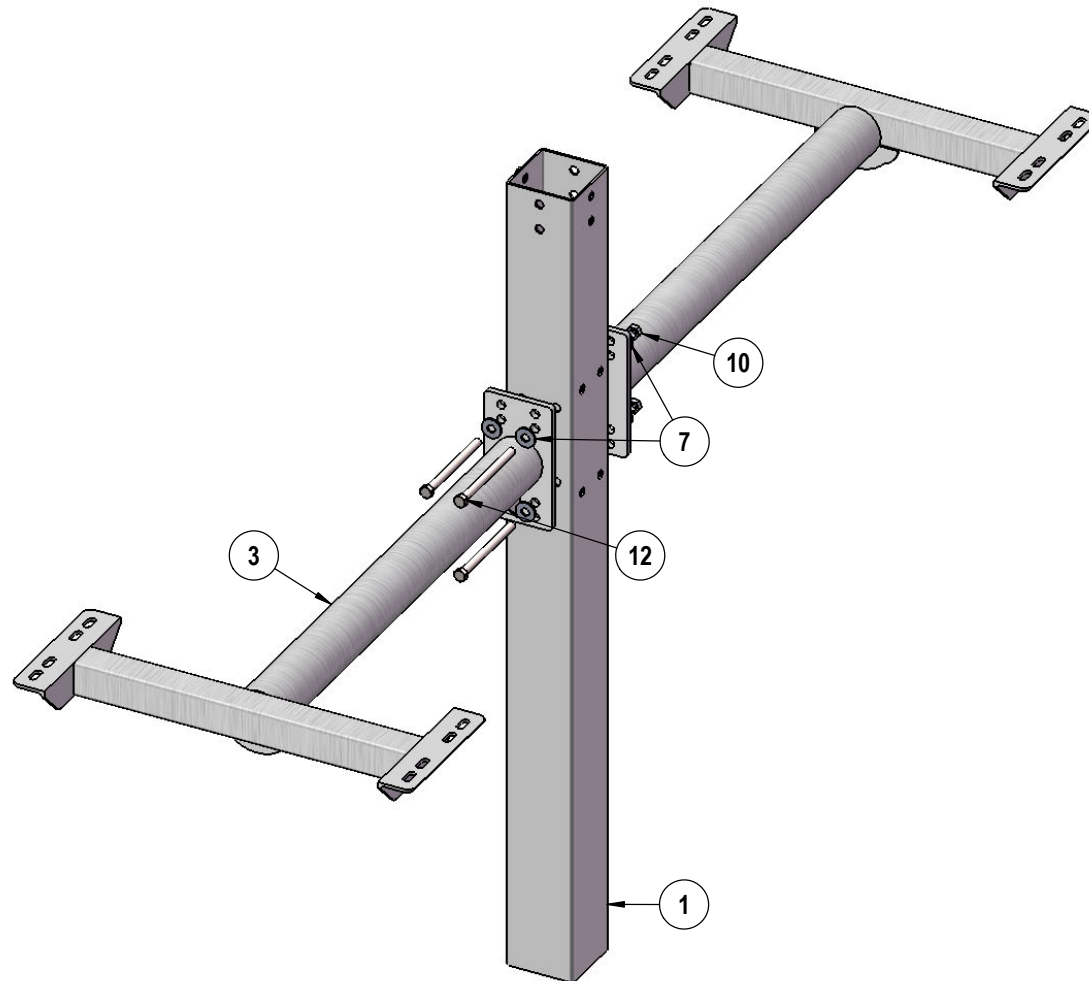

Attach the 338 Wood Arms to the 338 Post using specified hardware.

STEP 2

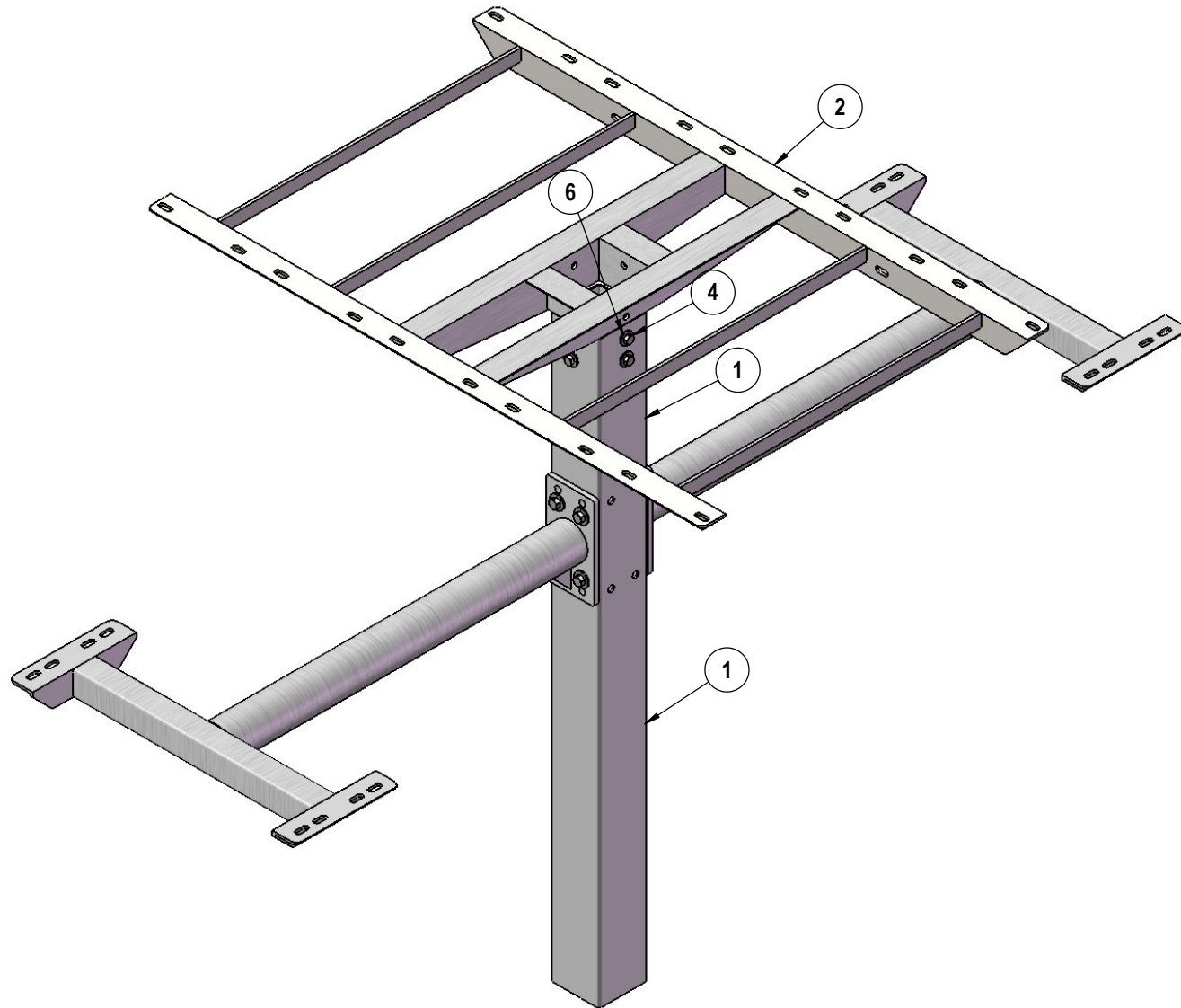

Attach the 48" wood-recycled H Frame to the 338 Post using specified hardware.

STEP 3

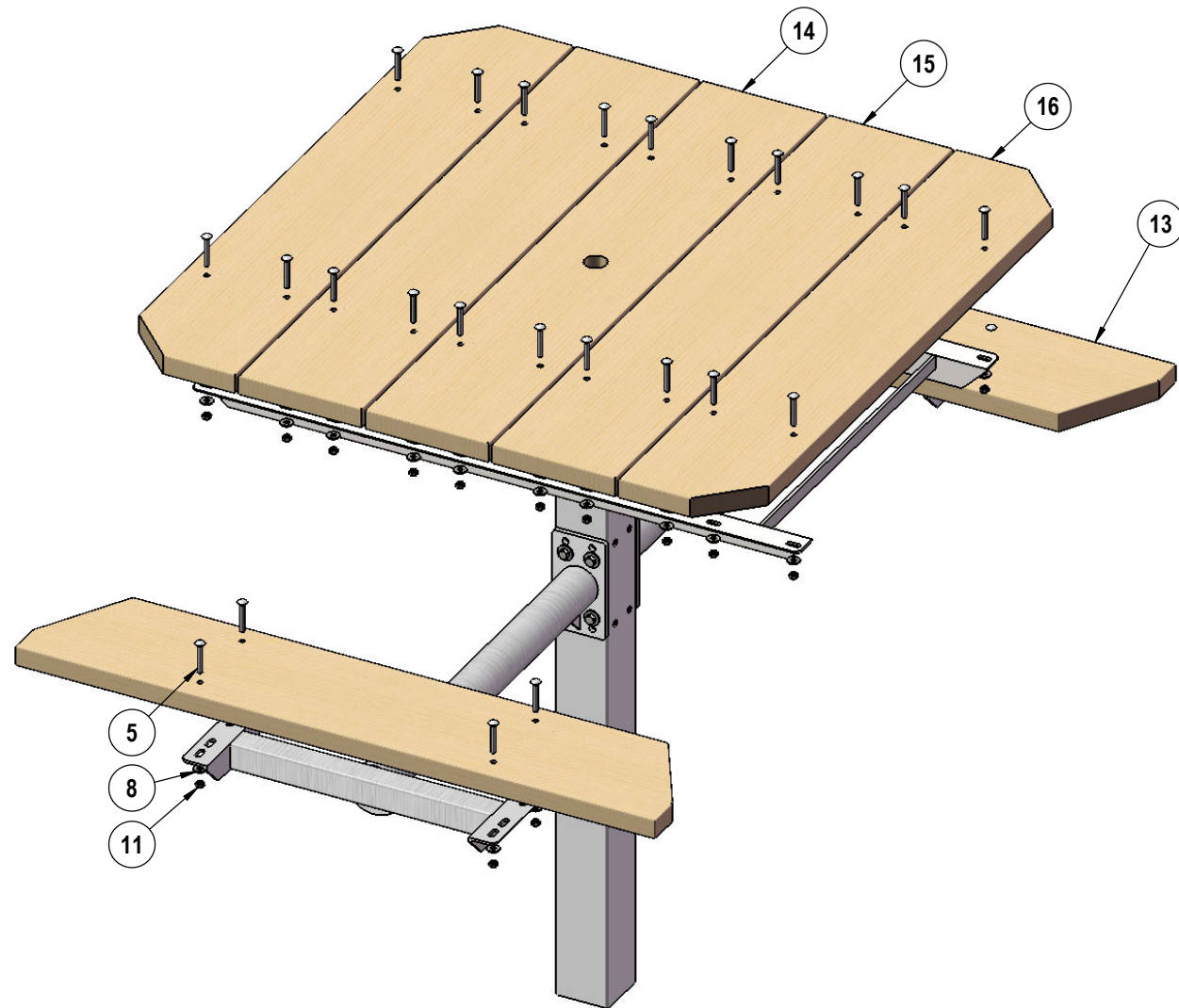

Attach the 48" Seat and Top Planks to the 338 Wood Arms and 338 wood-recycled H Frame as shown using specified hardware.

FOOTINGS

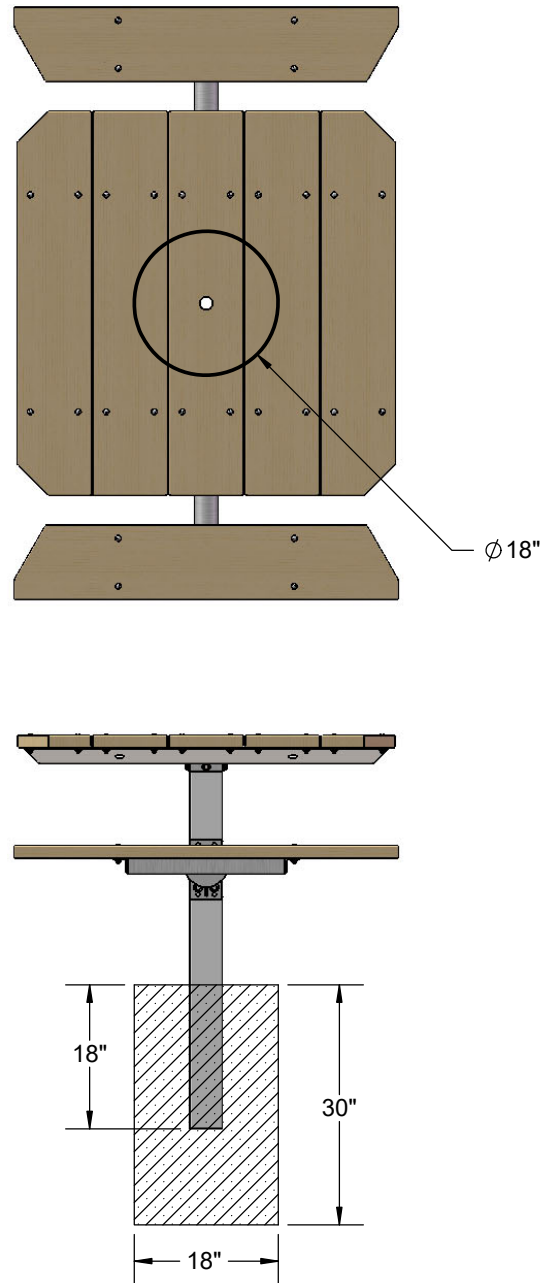

Estimated Required Concrete:
12 - 50lb Bags of Concrete Mix

OVERALL DIMENSIONS

